

0.050 FC

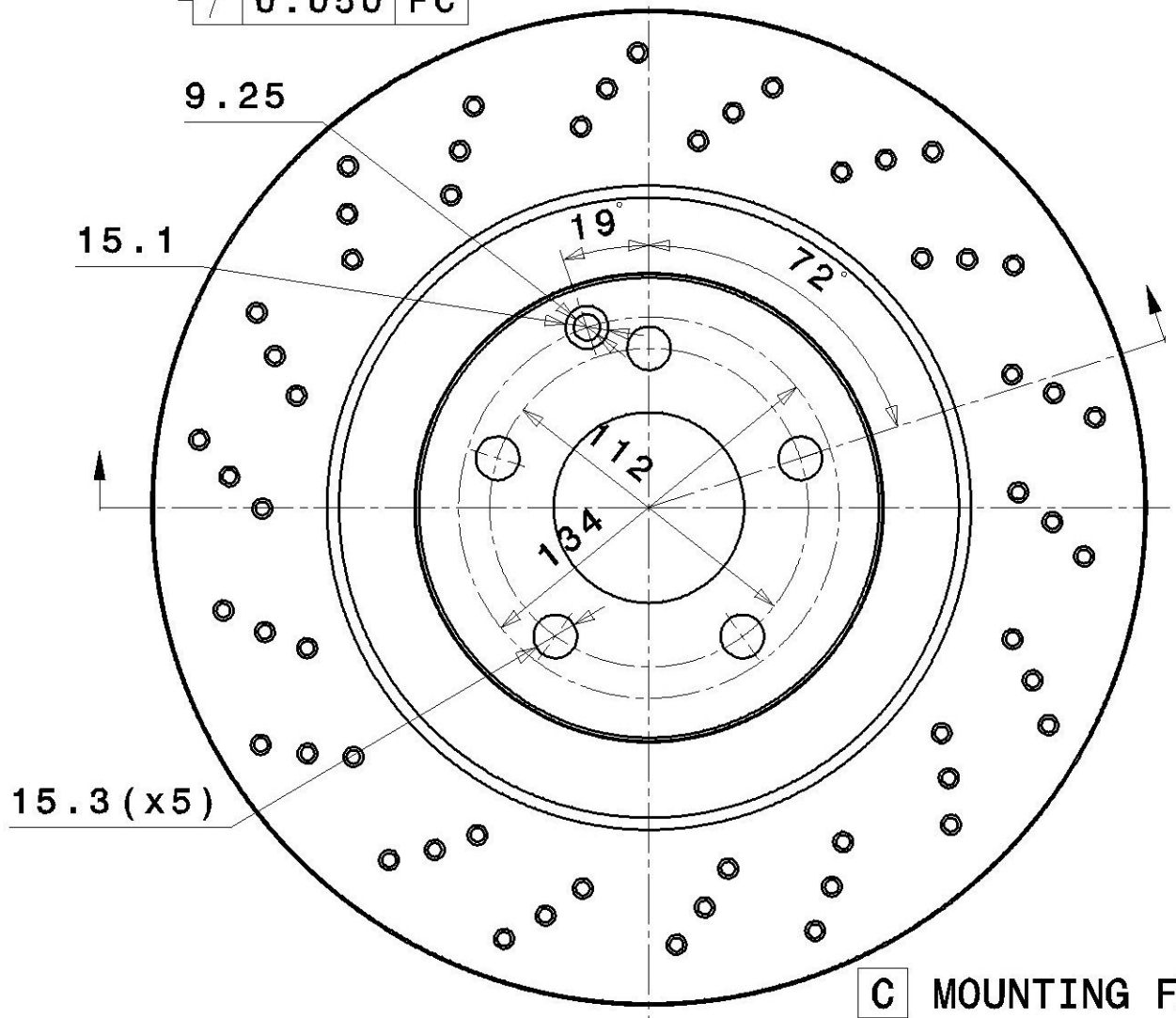

C MOUNTING FACE

Min. TH 30 mm

Weight 12.9 Kg

Type DA