

0.050 FC

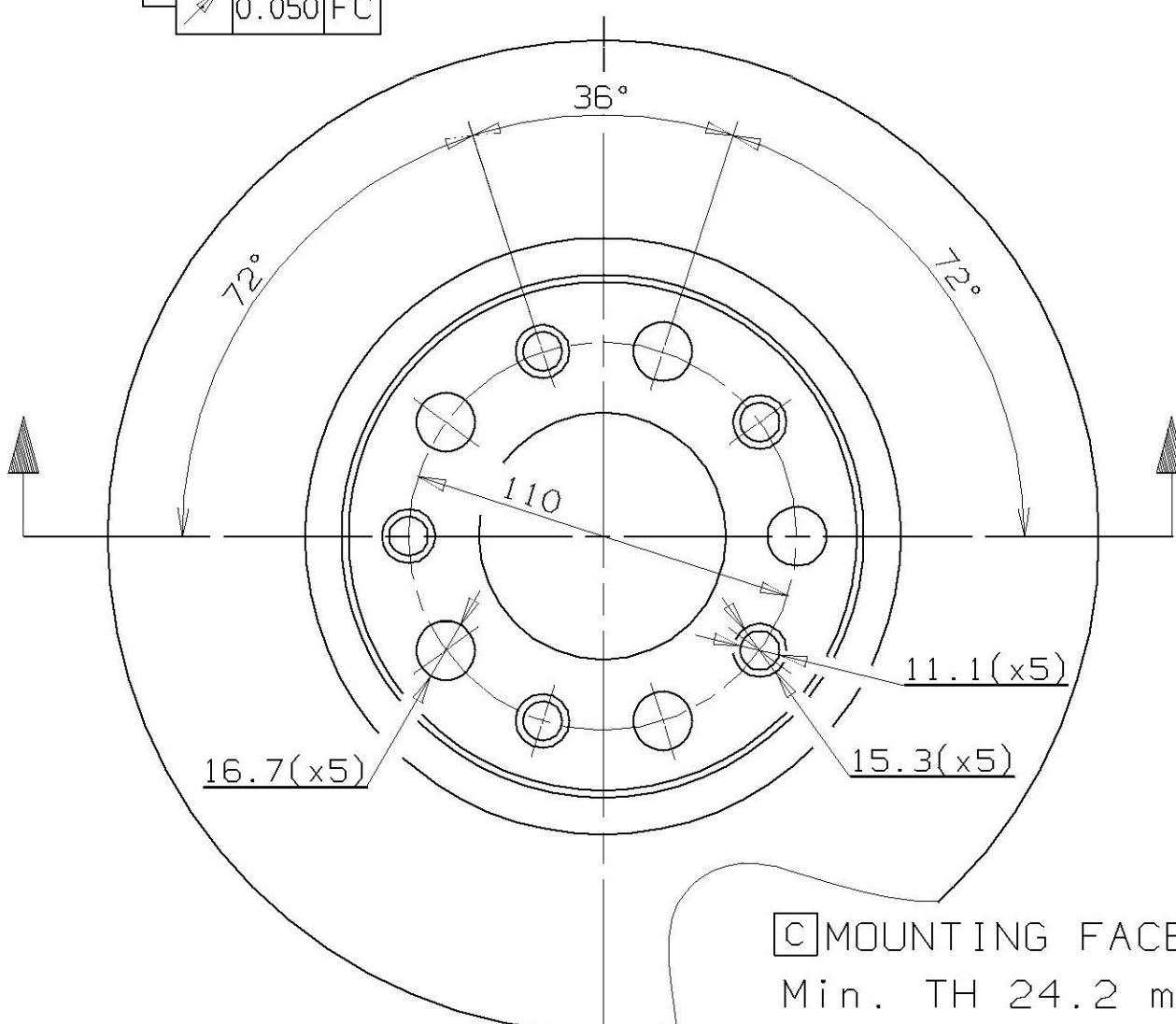

[C] MOUNTING FACE  
 Min. TH 24.2 mm  
 Weight 6.5 Kg

Type DA