

0.050 FC

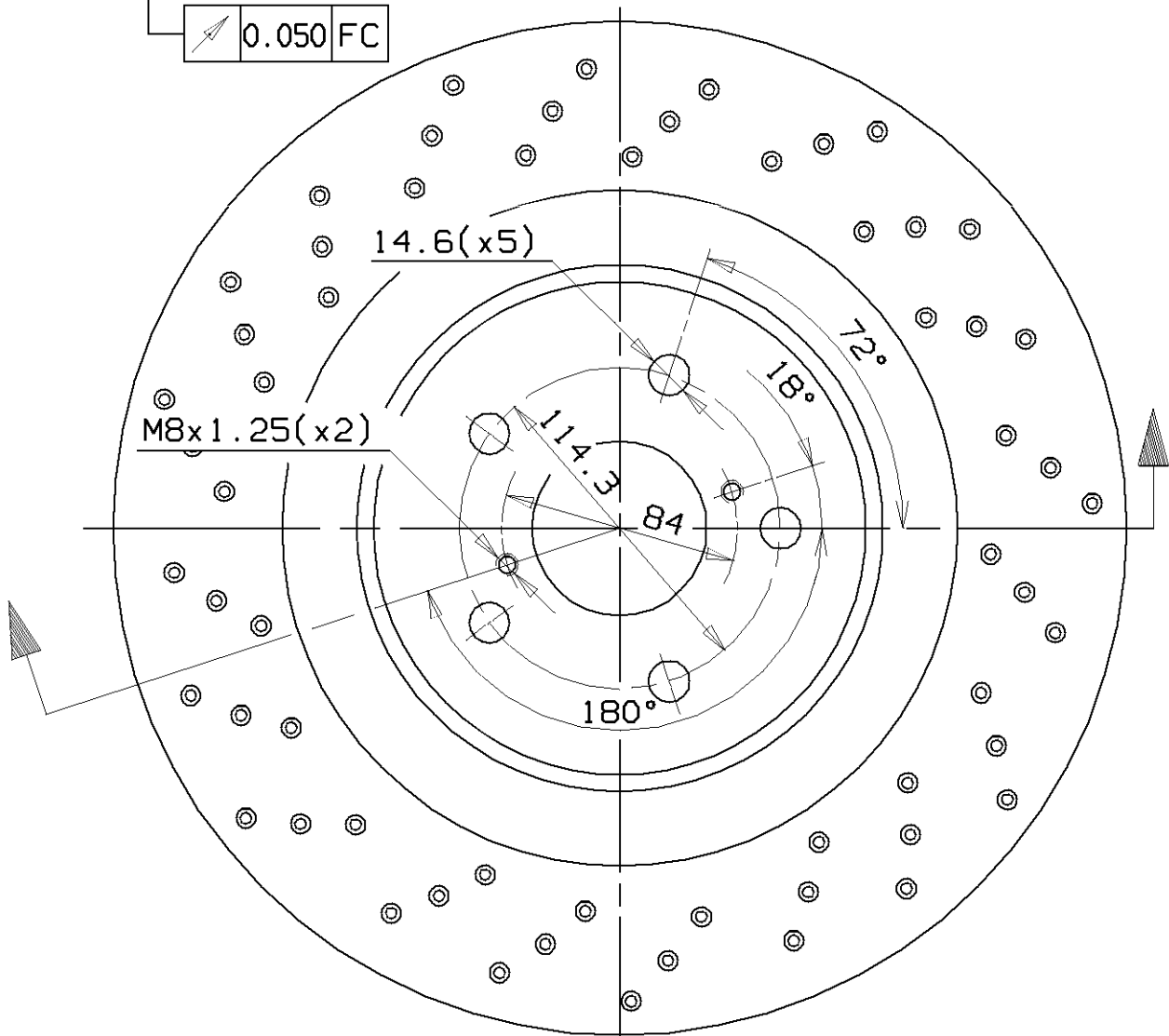

[C] MOUNTING FACE
 Min. TH 28 mm
 Weight 11.8 Kg

Type DA