

0.050FC

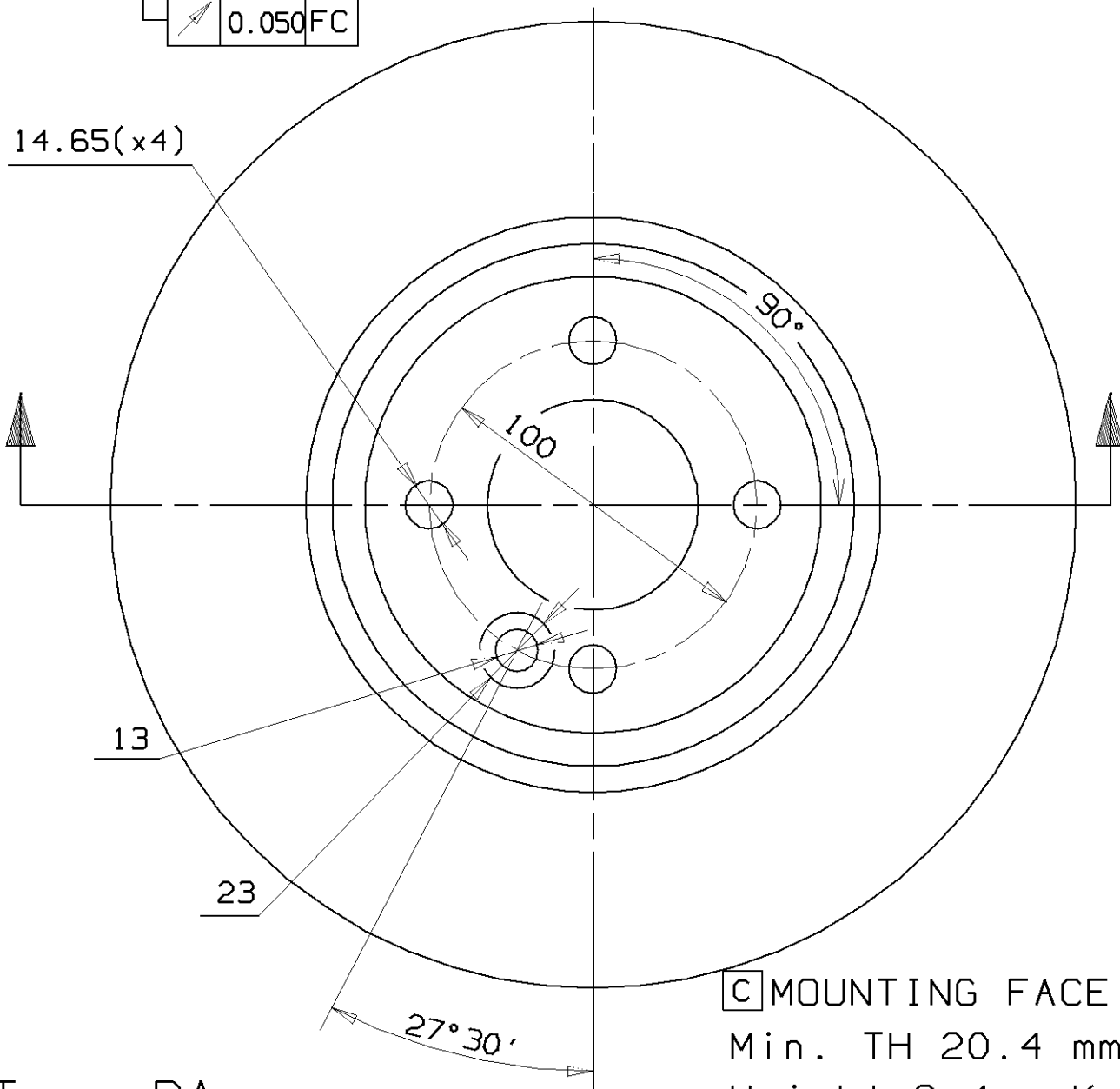

[C] MOUNTING FACE
 Min. TH 20.4 mm
 Weight 6.4 Kg

Type DA