

0.050 FC

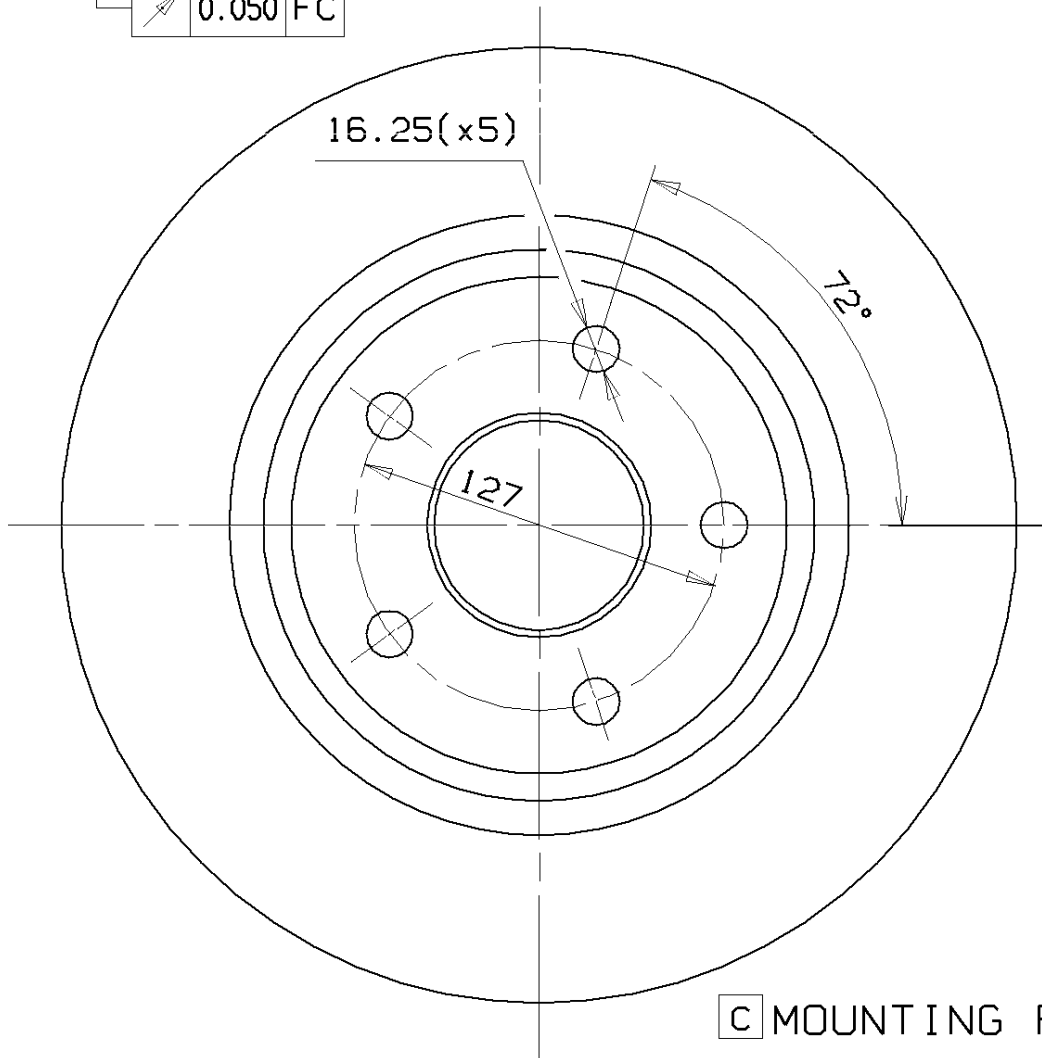

[C] MOUNTING FACE
 Min. TH 28.5 mm
 Weight 10.5 Kg

Type DA