

0.050FC

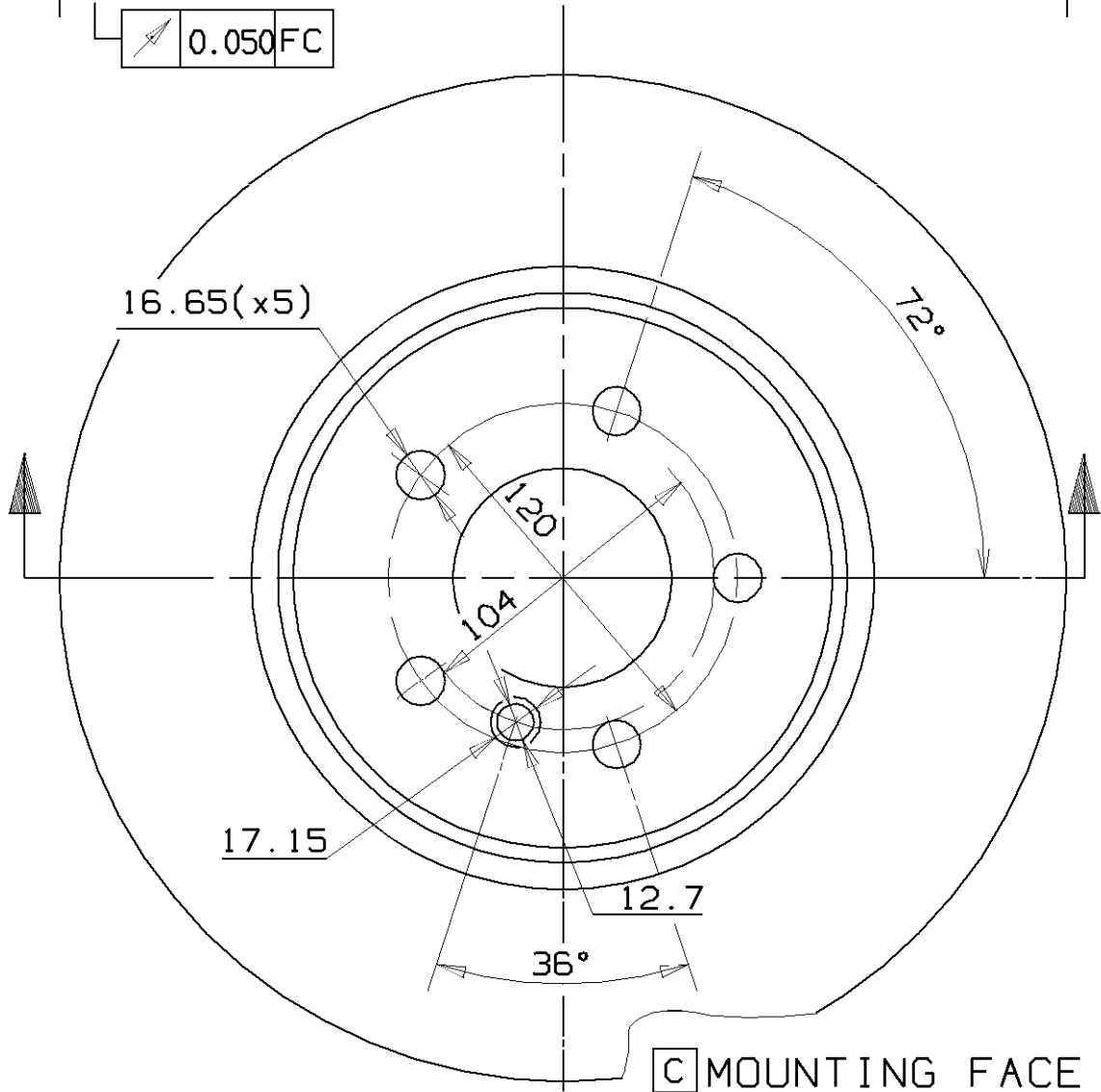

[C] MOUNTING FACE
 Min. TH 22.4 mm
 Weight 9.4 Kg

Type DA