

0.050 FC

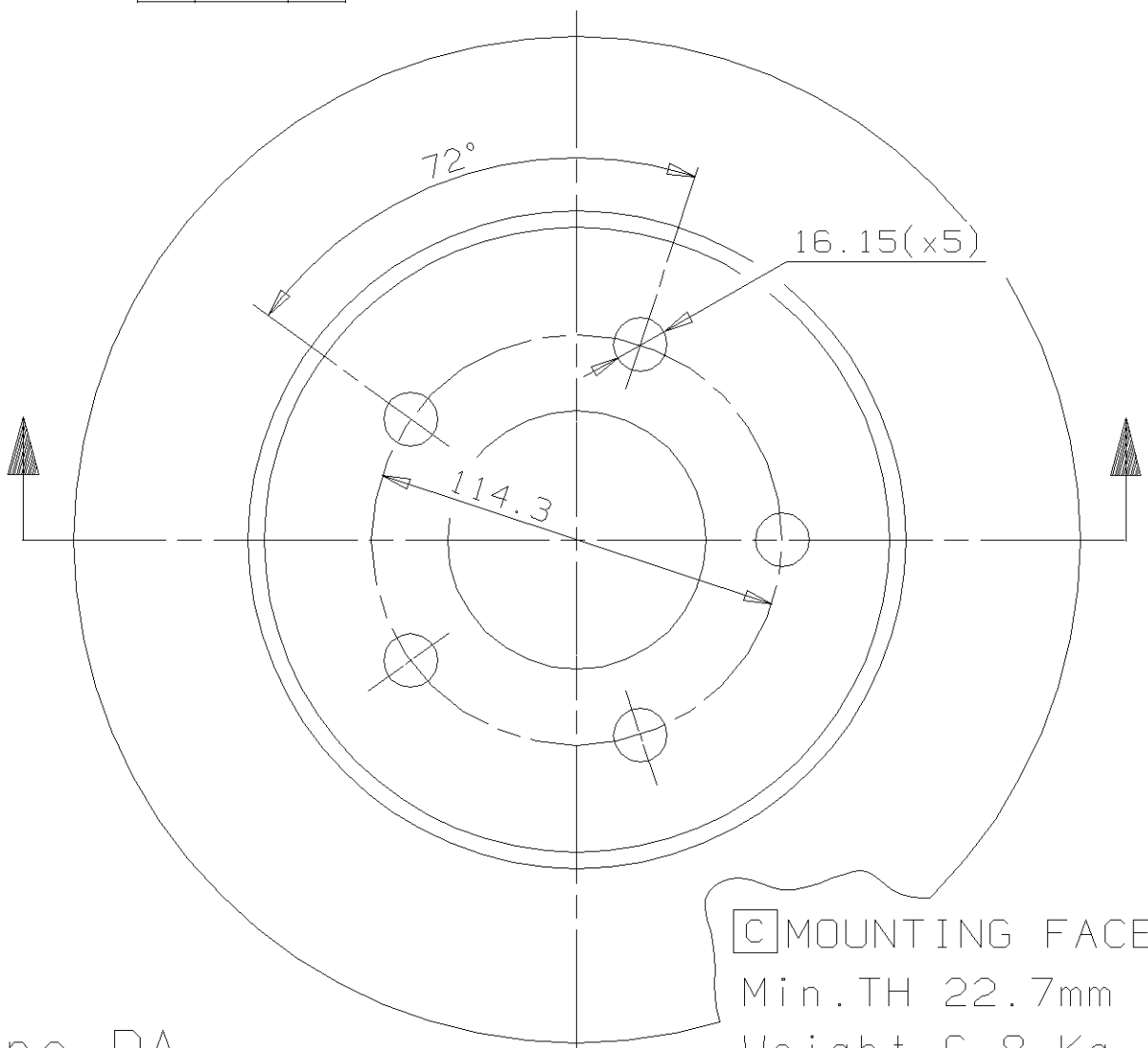

[C] MOUNTING FACE  
 Min. TH 22.7mm  
 Weight 6.8 Kg

Type DA