

0.050FC

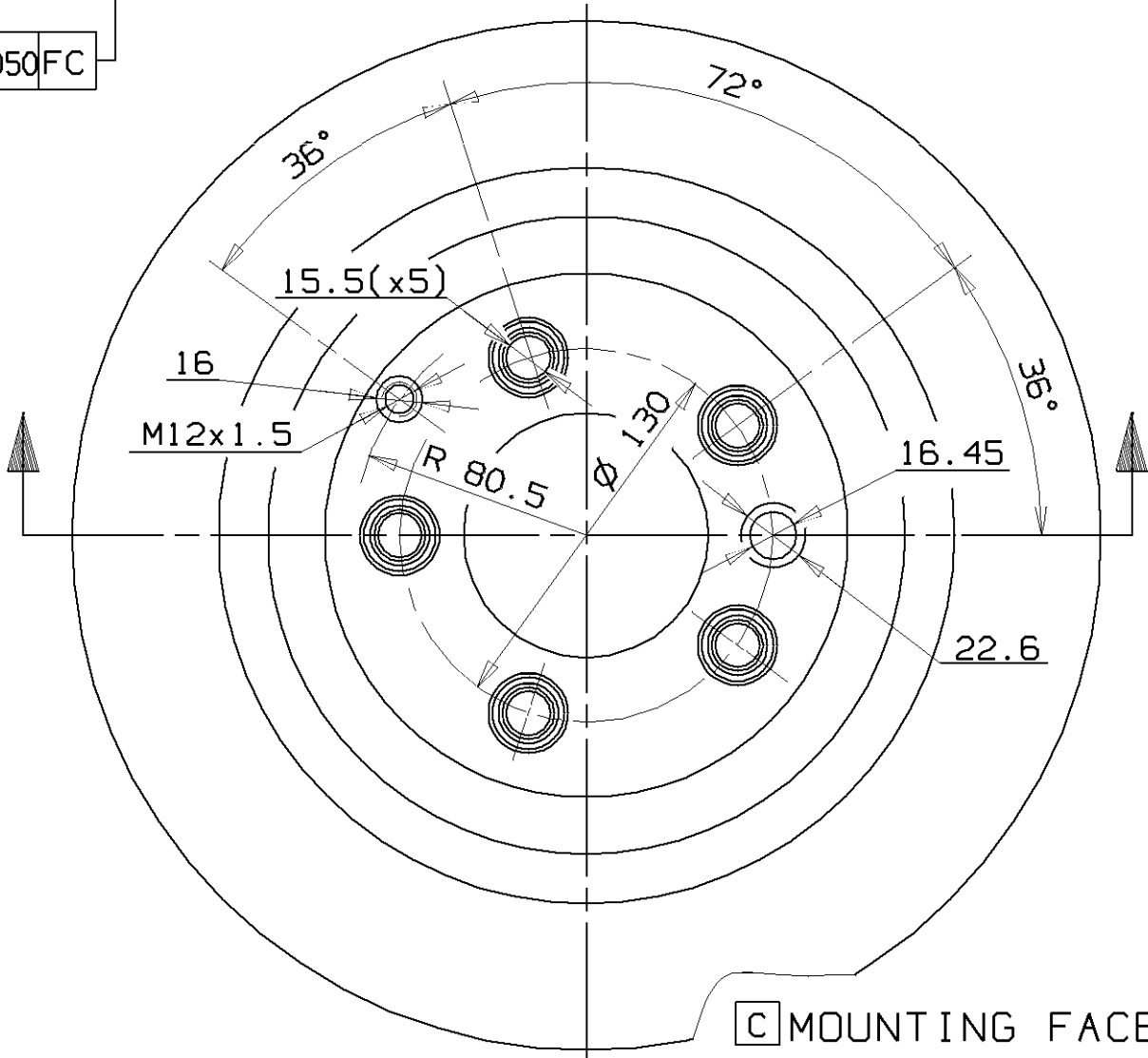

C MOUNTING FACE

Min. TH 26 mm

Weight 9.7 Kg

Type DA