

0.080 FC

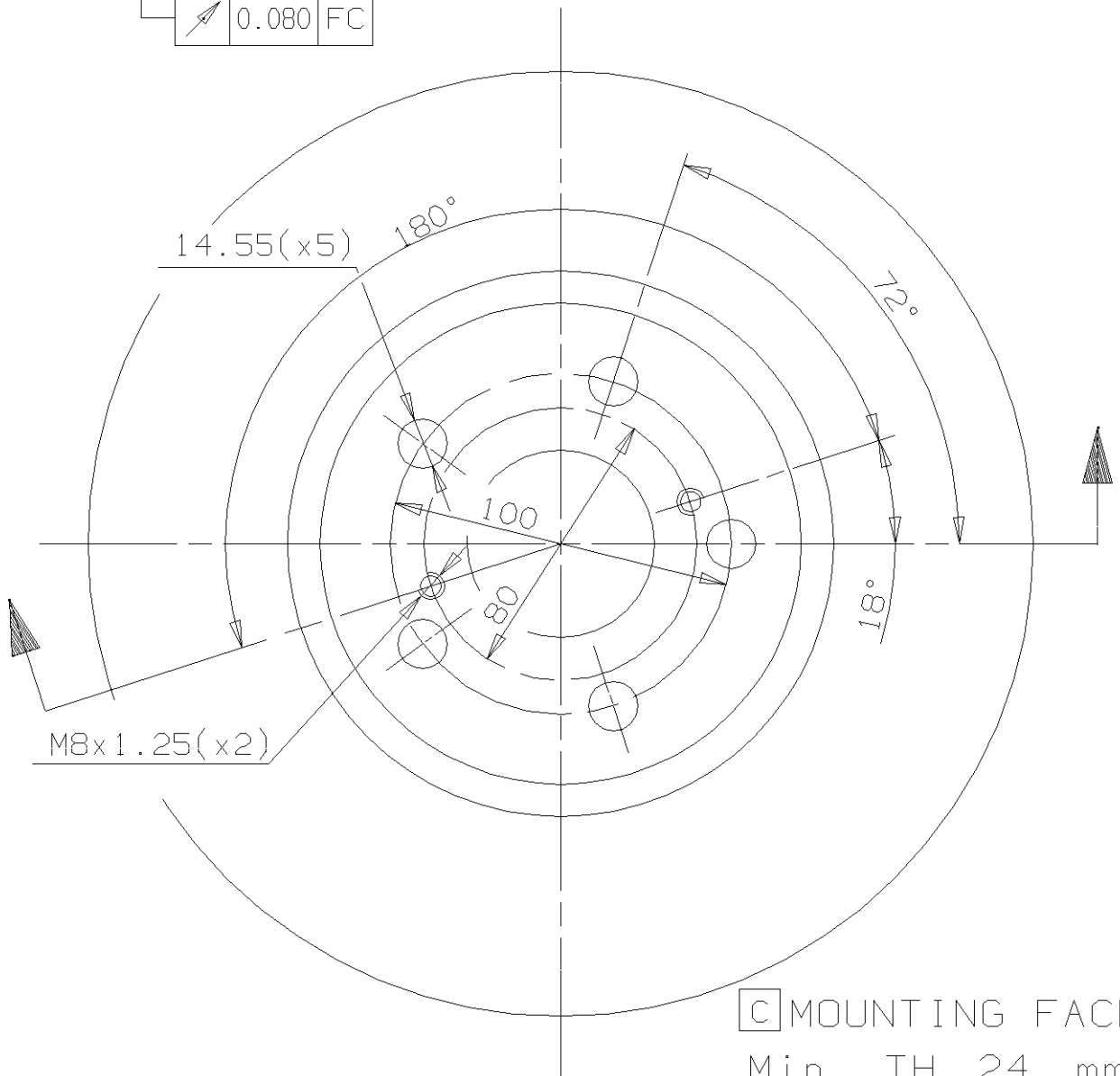

C MOUNTING FACE  
 Min. TH 24 mm  
 Weight 6.9 Kg

Type DA