

0.050 FC

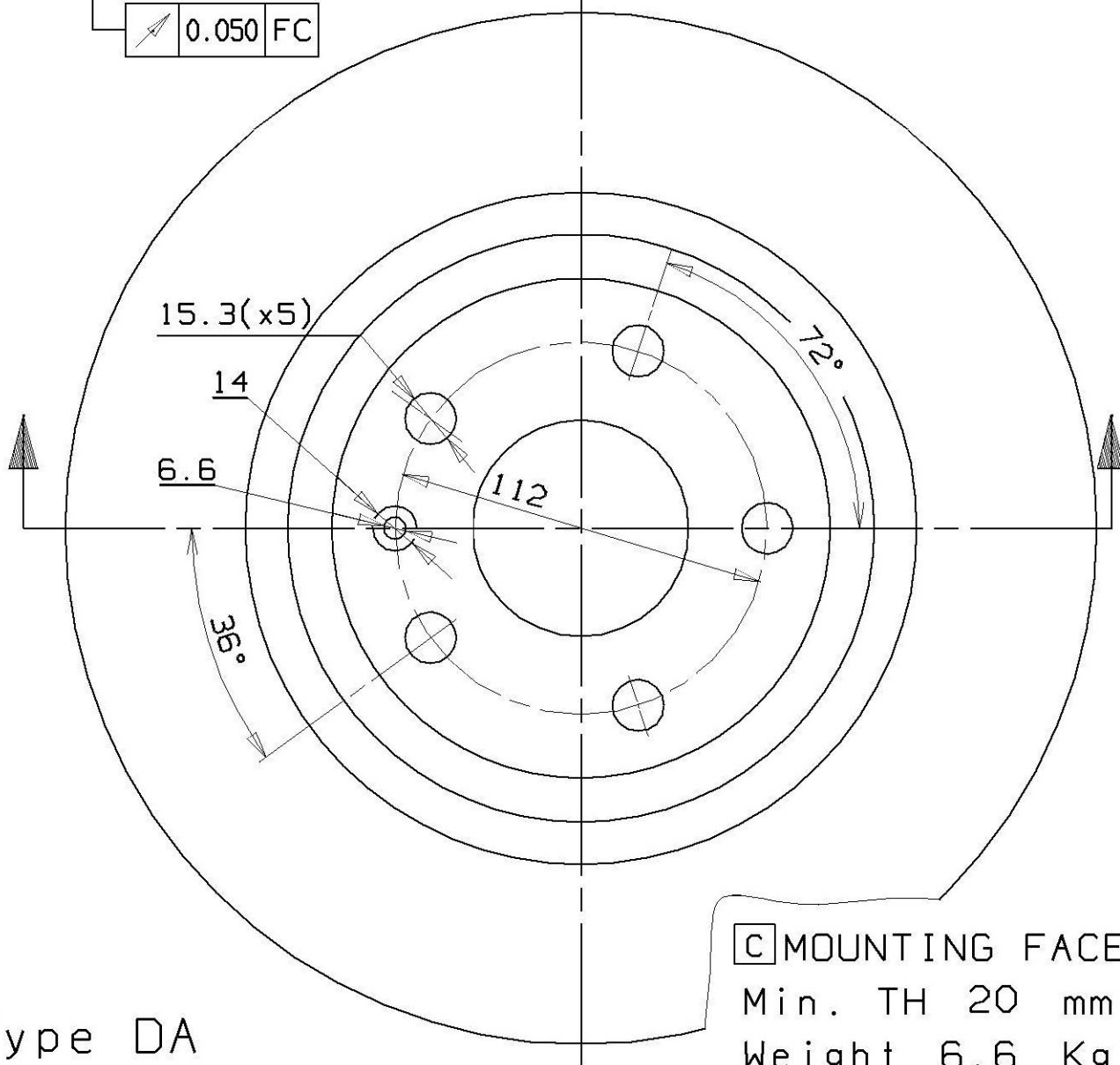

[C] MOUNTING FACE

Min. TH 20 mm

Weight 6.6 Kg

Type DA