

0.050 FC

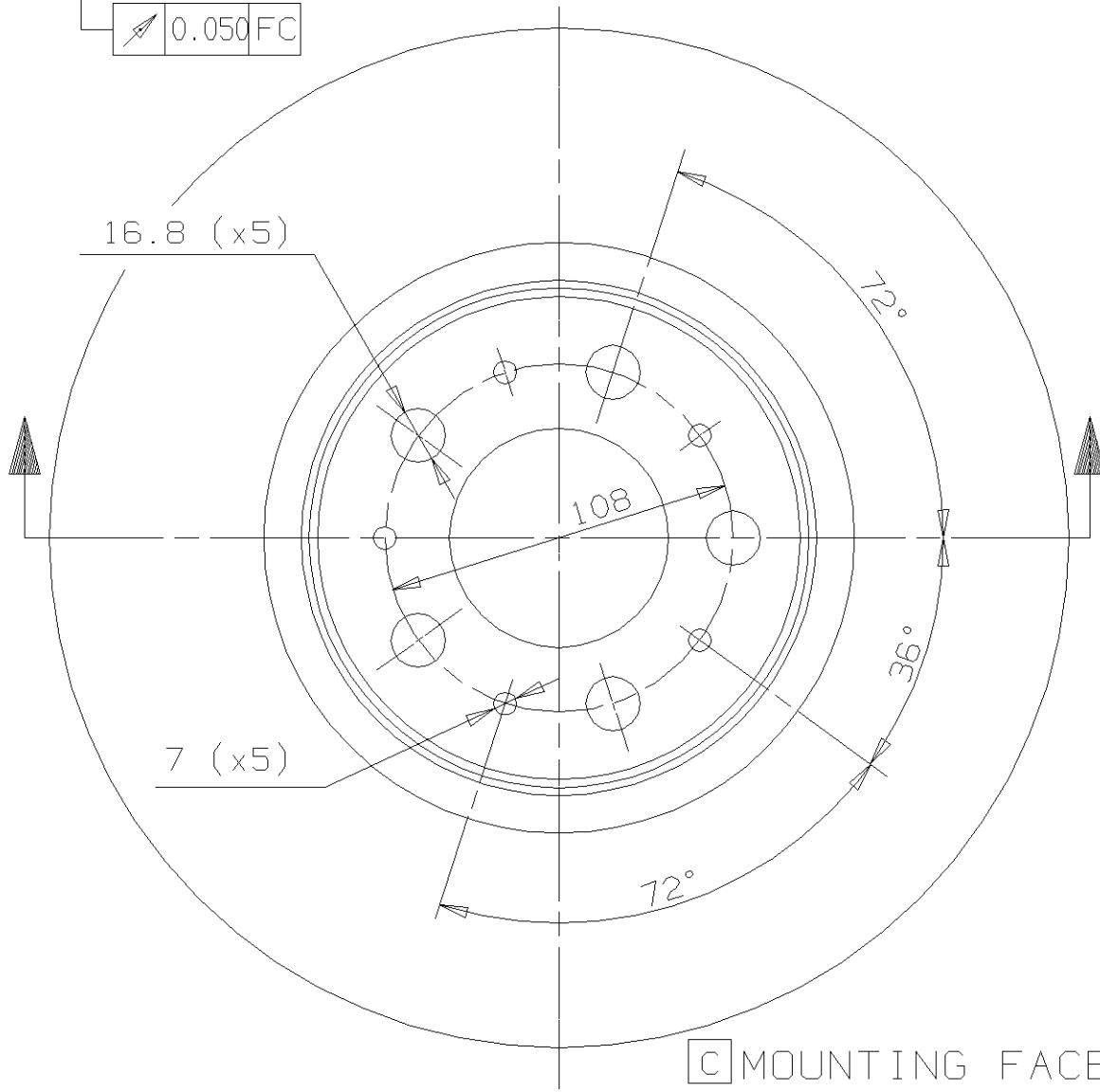

[C] MOUNTING FACE
 Min. TH 25 mm
 Weight 8.5 Kg

Type DA