

	0.080	FC
--	-------	----

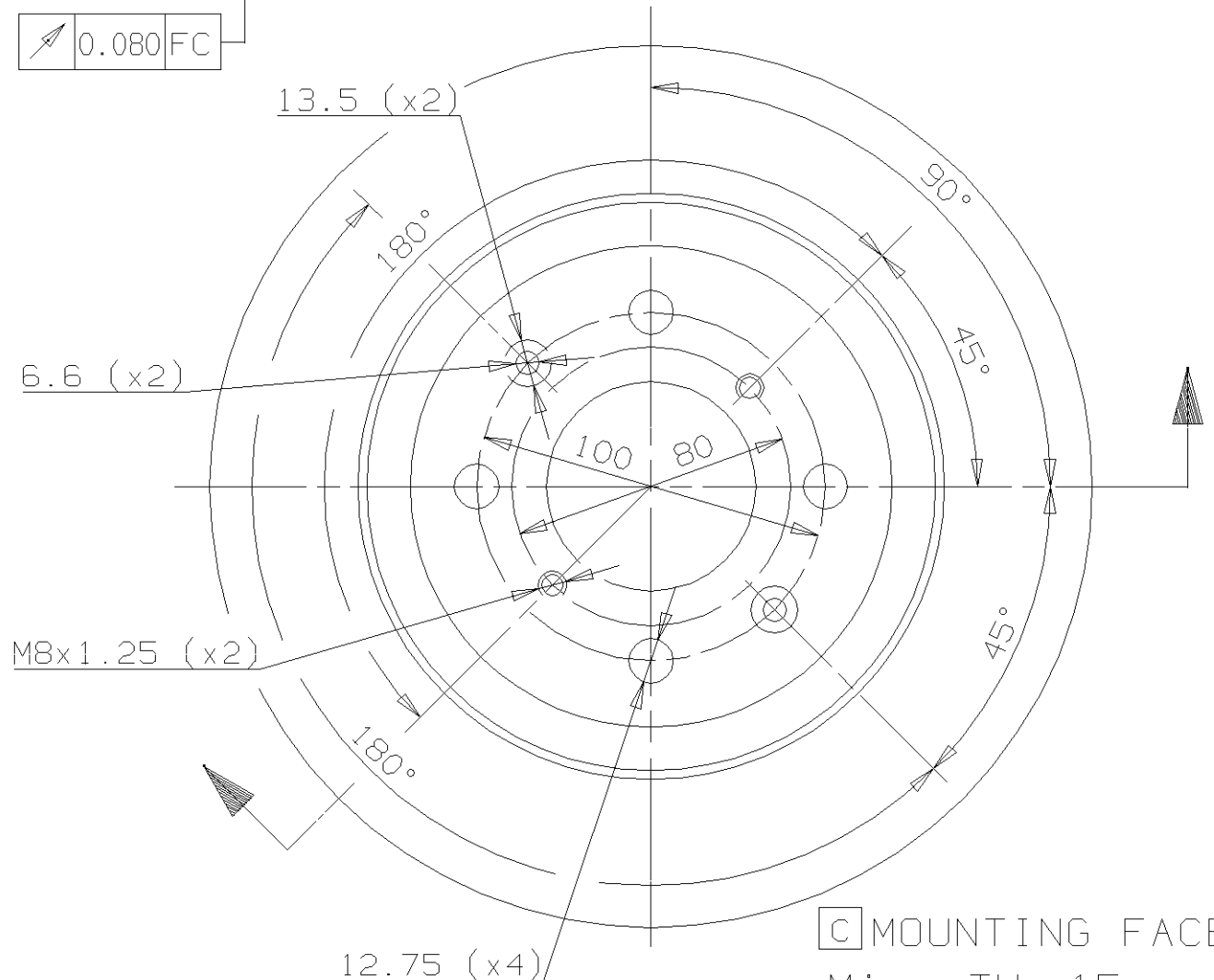

C MOUNTING FACE
 Min. TH 15 mm
 Weight 4.1 Kg

Type DA