

0.050 FC

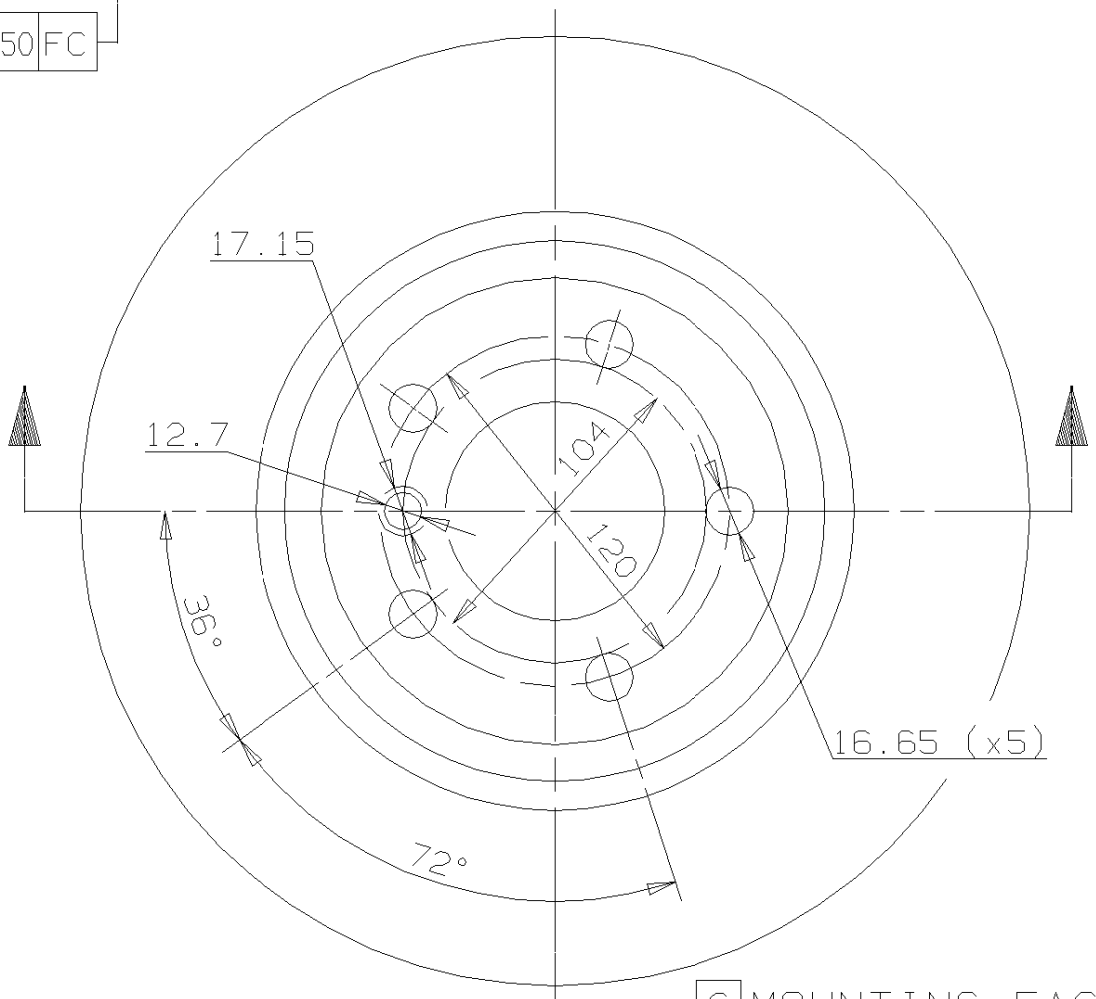

[C] MOUNTING FACE

Min. TH 23.4mm

Weight 9.1 Kg

Type DA