

0.050FC

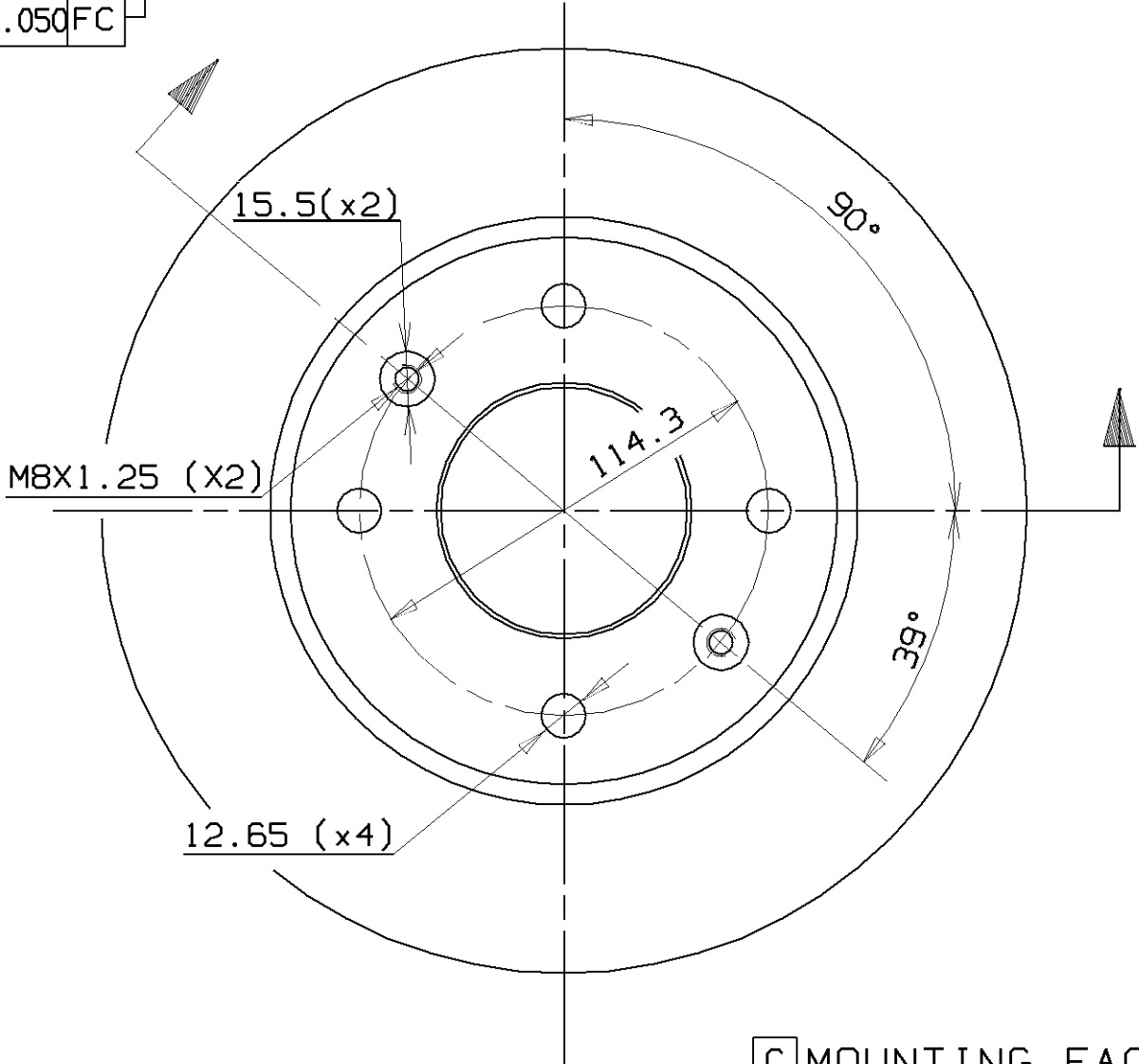

[C] MOUNTING FACE
 Min. TH 22.1 mm
 Weight 5.9 Kg

Type DA