

0.050 FC

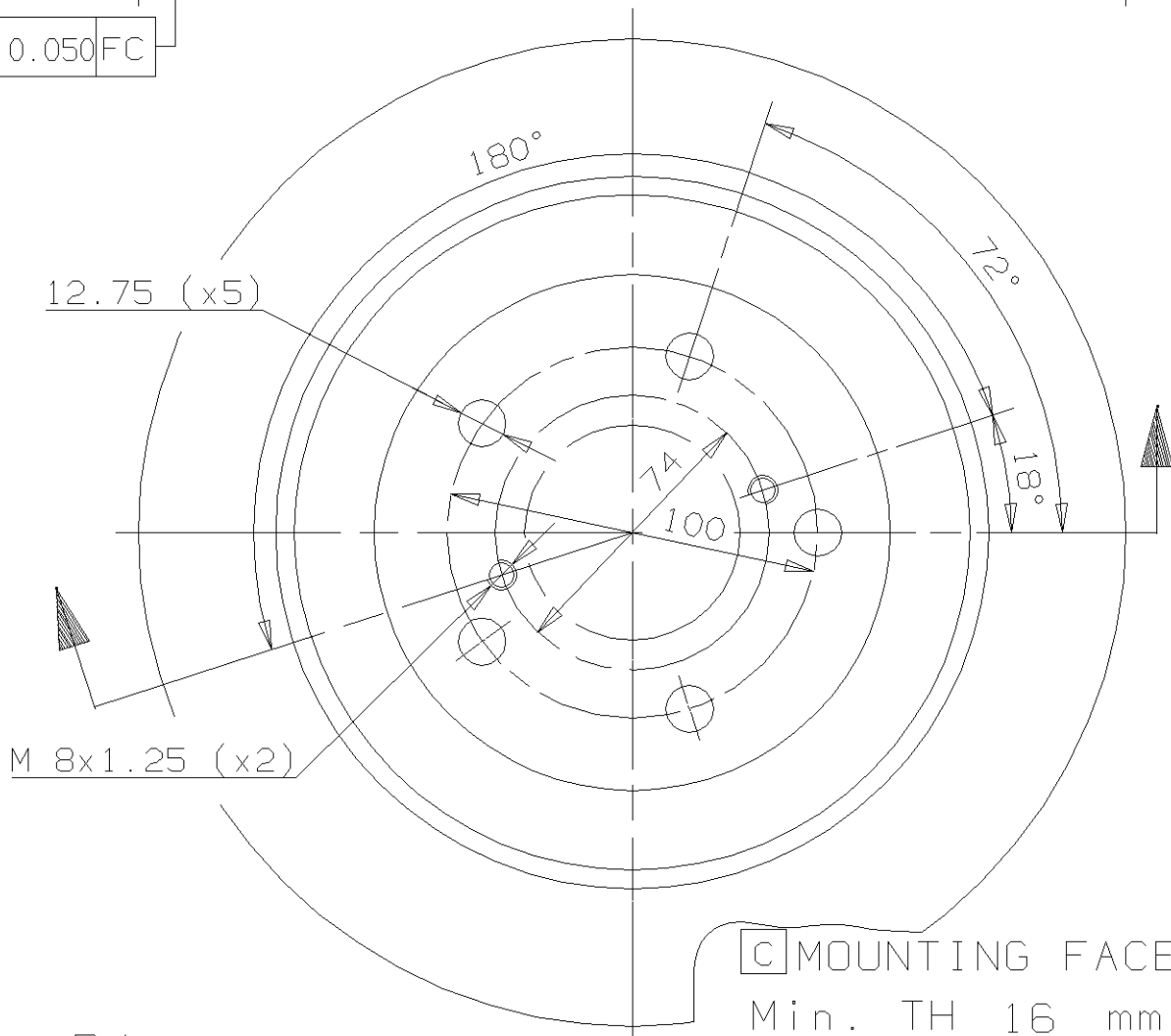

C MOUNTING FACE
 Min. TH 16 mm
 Weight 5.1 Kg

Type DA