

0.050 FC

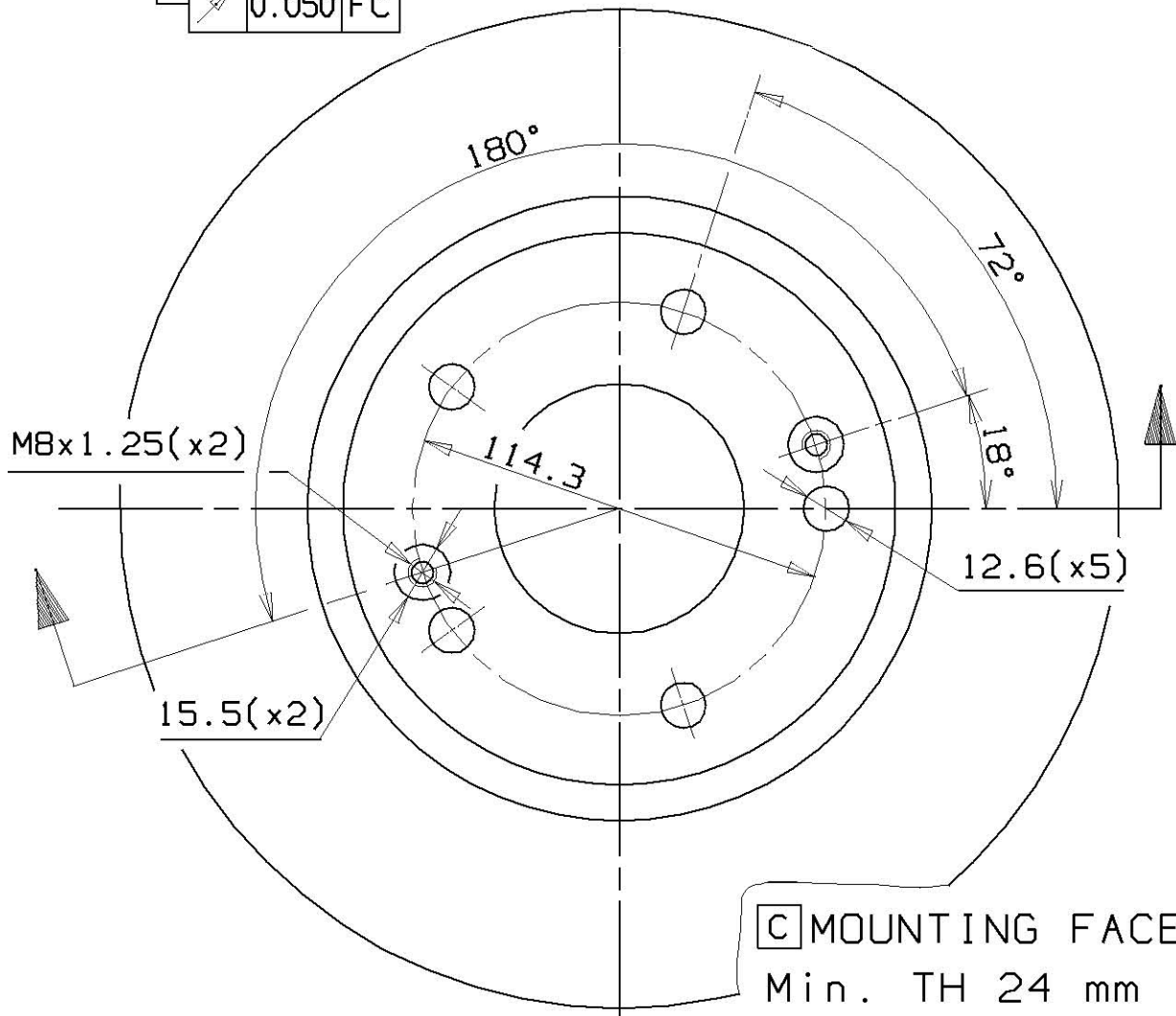

C MOUNTING FACE
 Min. TH 24 mm
 Weight 6.6 Kg

Type DA