

0.050 FC

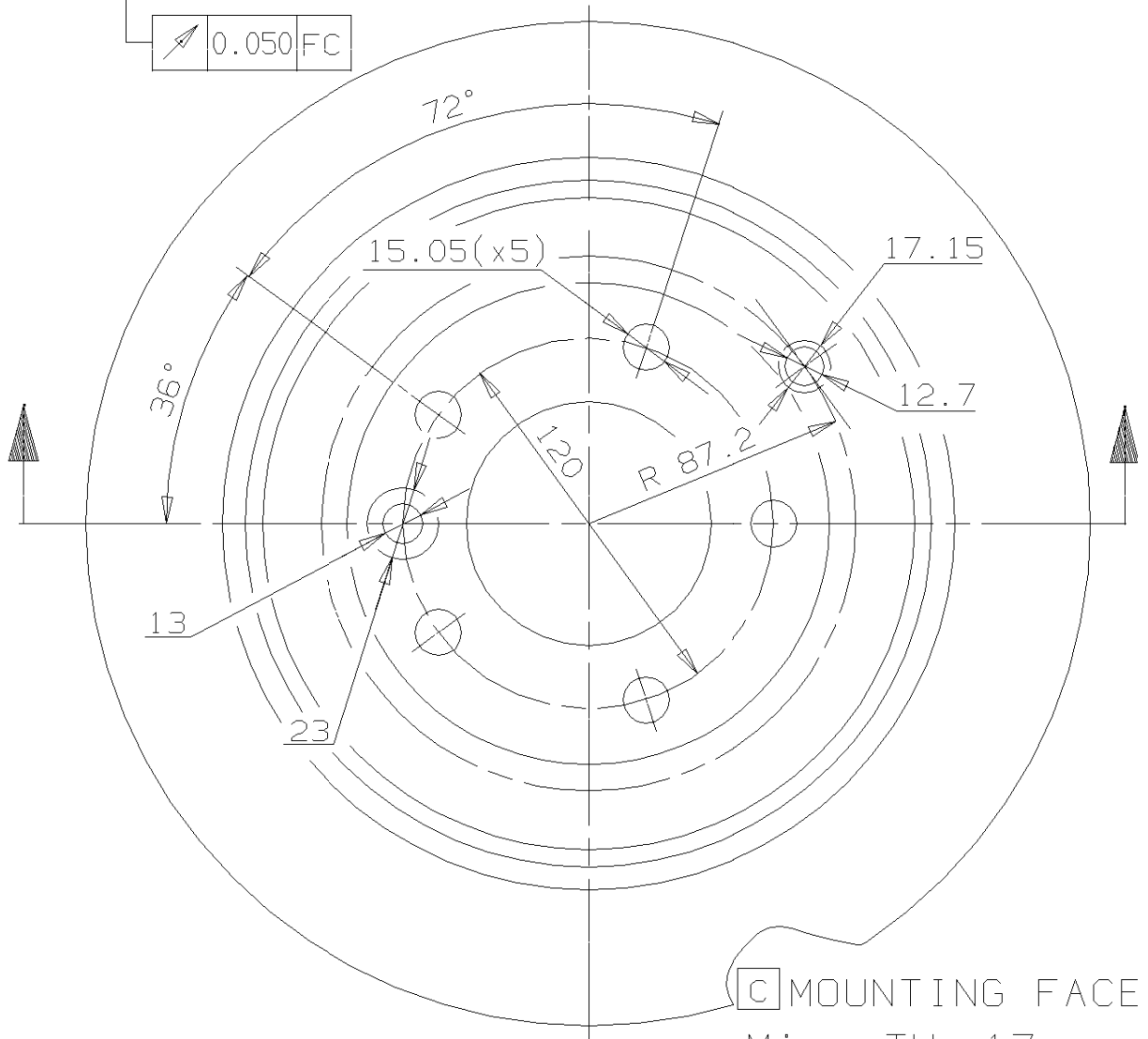

C MOUNTING FACE

Min. TH 17 mm

Weight 7.8 Kg

Type DA