

0.050 FC

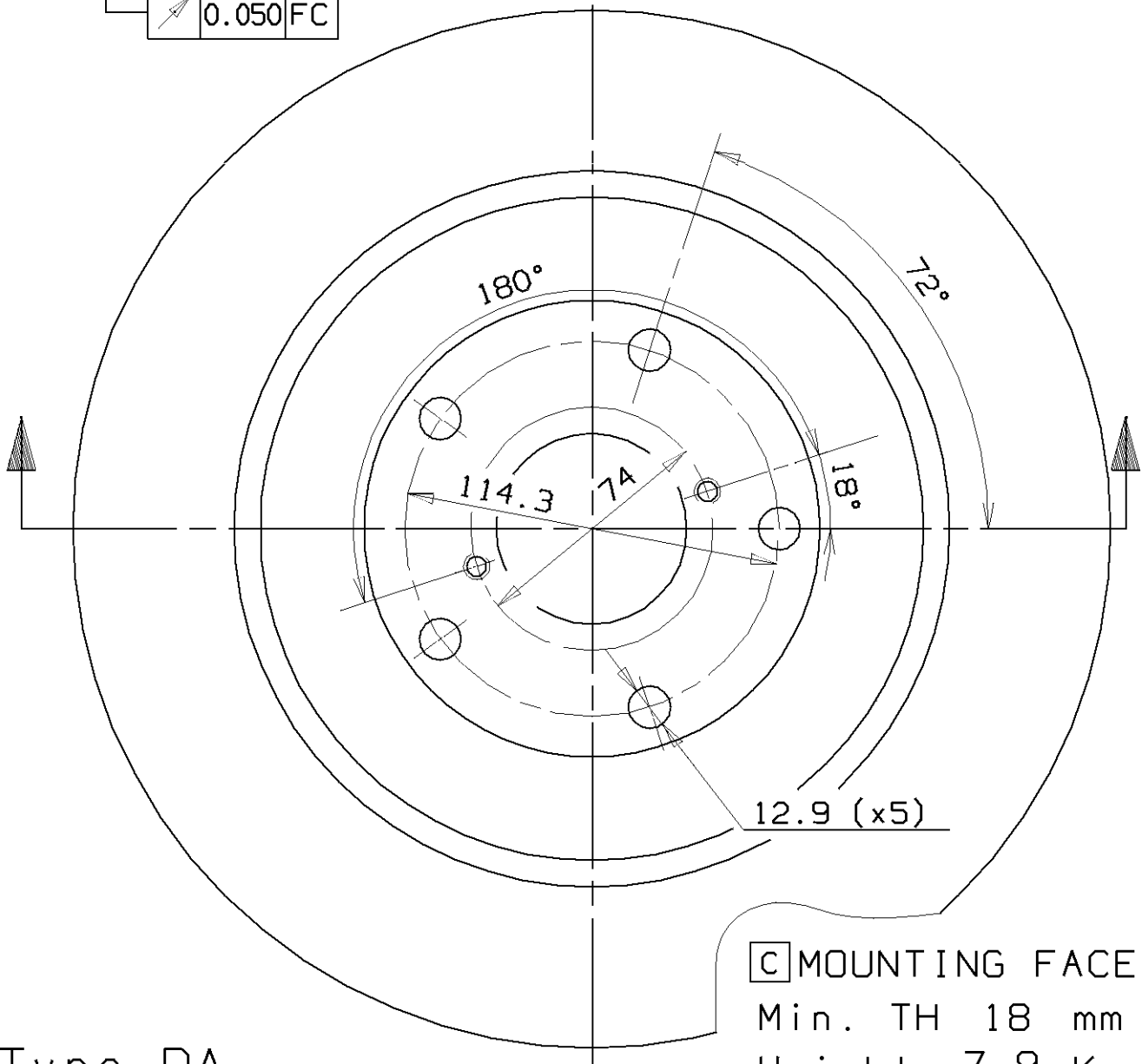

C MOUNTING FACE
 Min. TH 18 mm
 Weight 7.9 Kg

Type DA