

0.050 FC

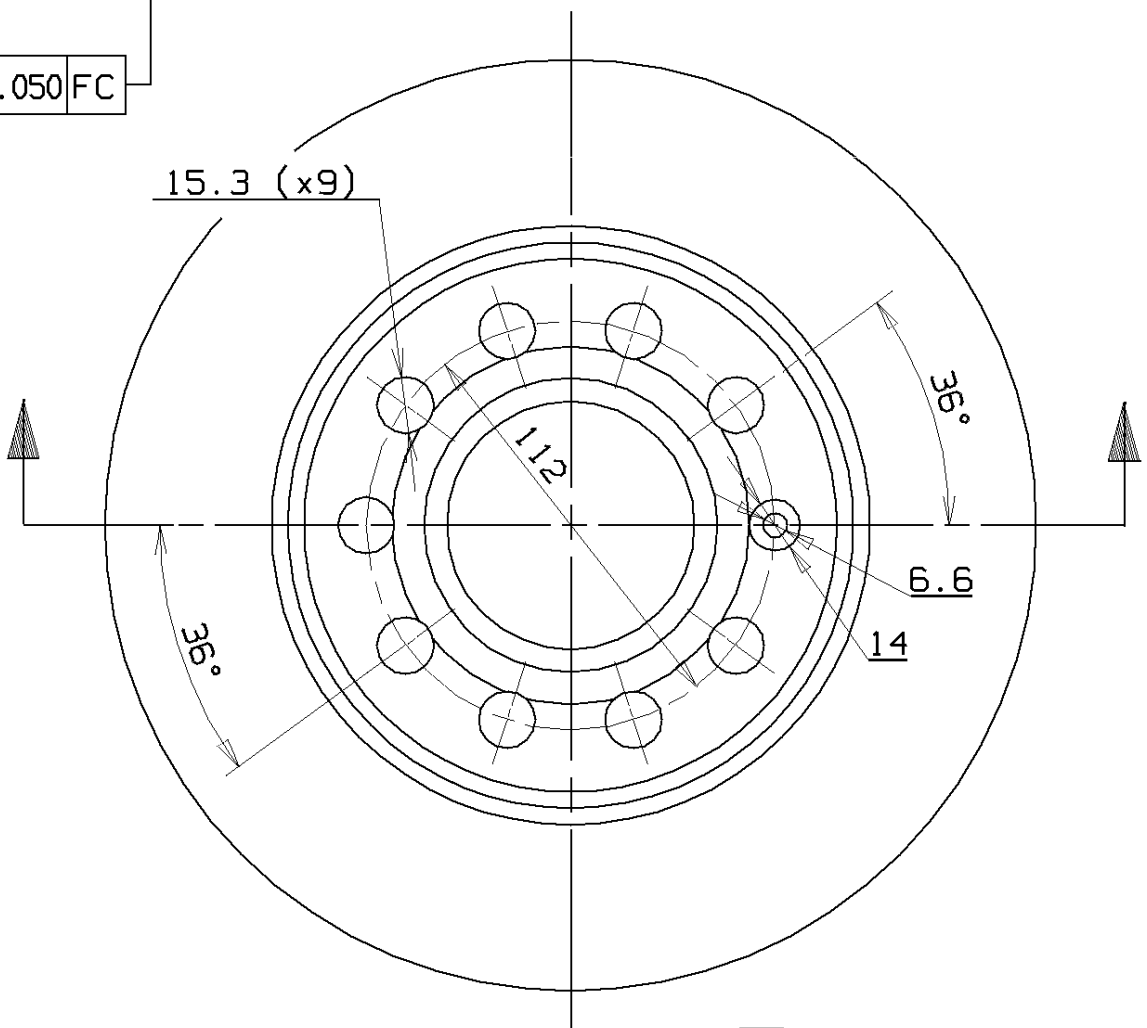

[C] MOUNTING FACE

Min. TH 10 mm

Weight 3.8 Kg

Type DP