

0.050 FC

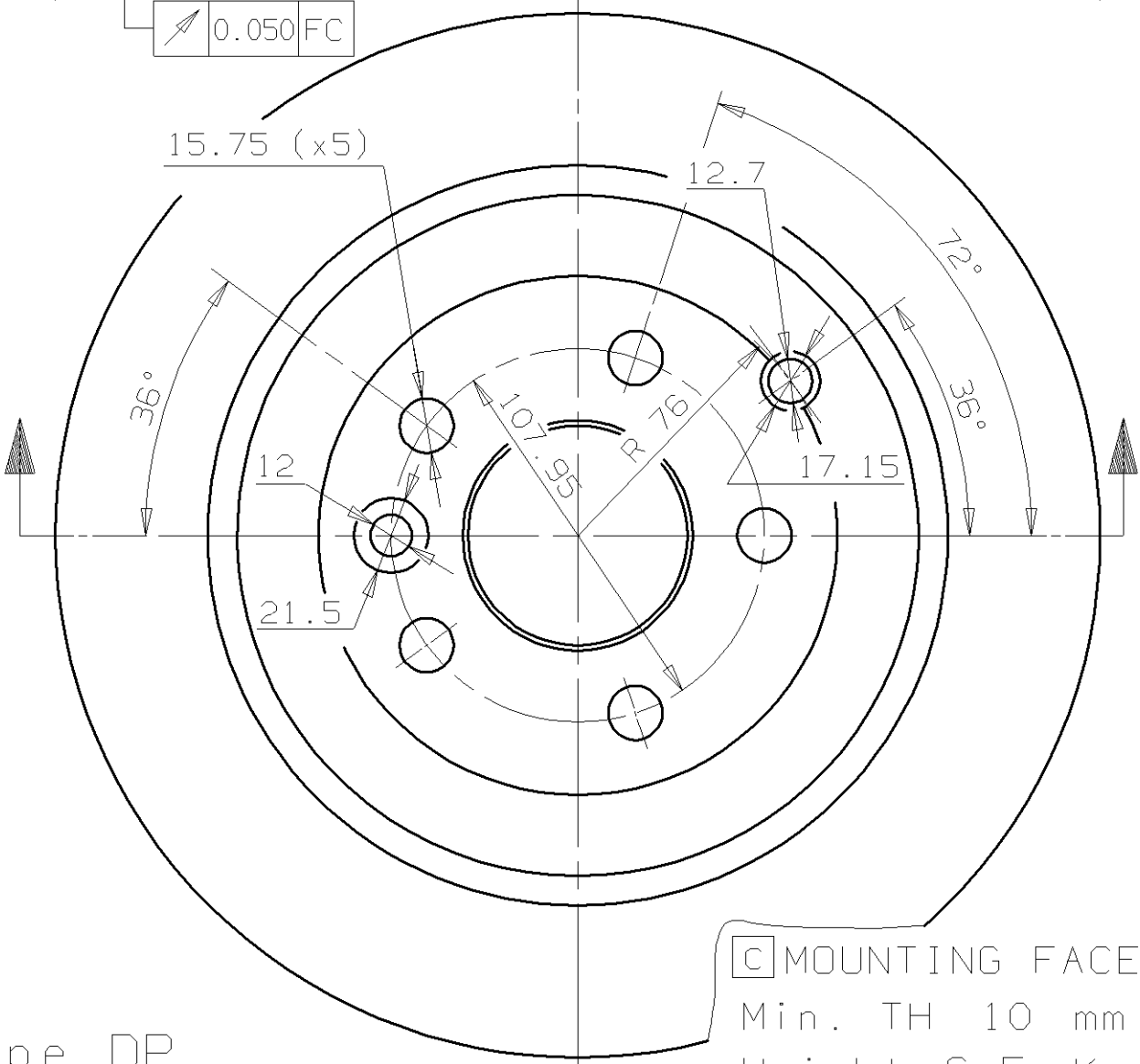

MOUNTING FACE
 Min. TH 10 mm
 Weight 6.5 Kg

Type DP