

0.050 FC

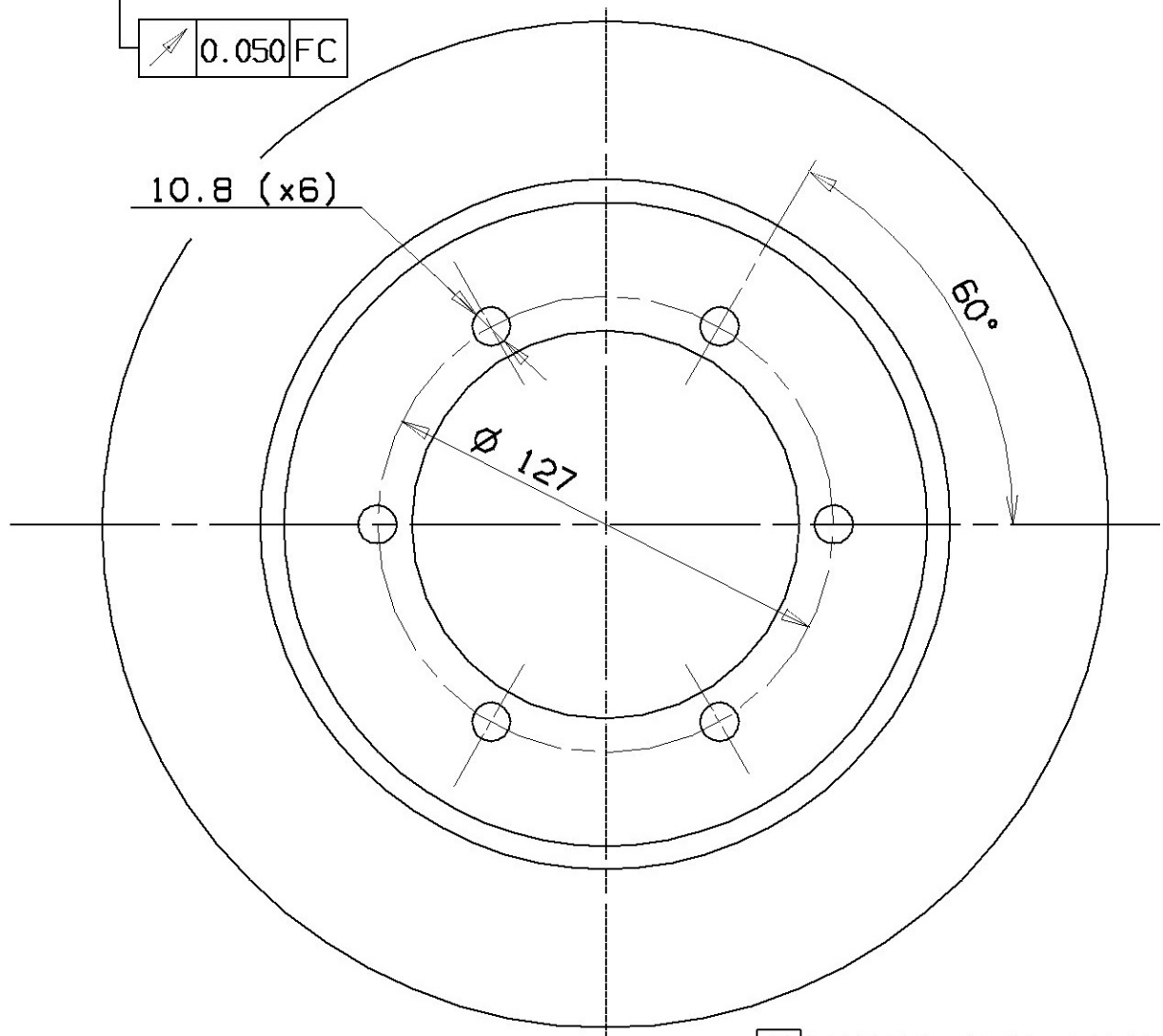

MOUNTING FACE

Min. TH 13 mm

Weight 6.5 Kg

Type DP