

0.050 FC

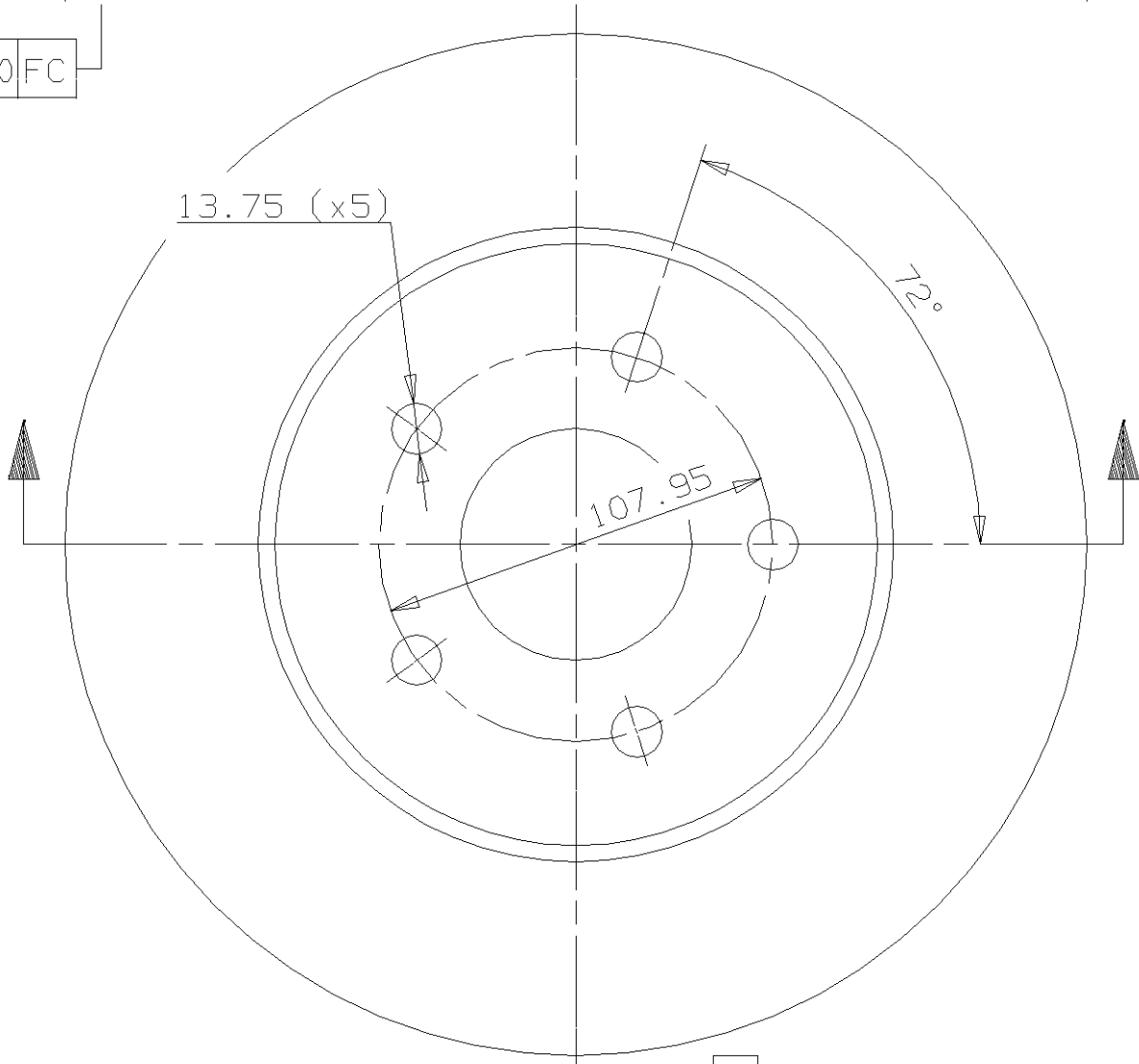

[C] MOUNTING FACE
 Min. TH 10 mm
 Weight 4.9 Kg

Type DP