

0.050 FC

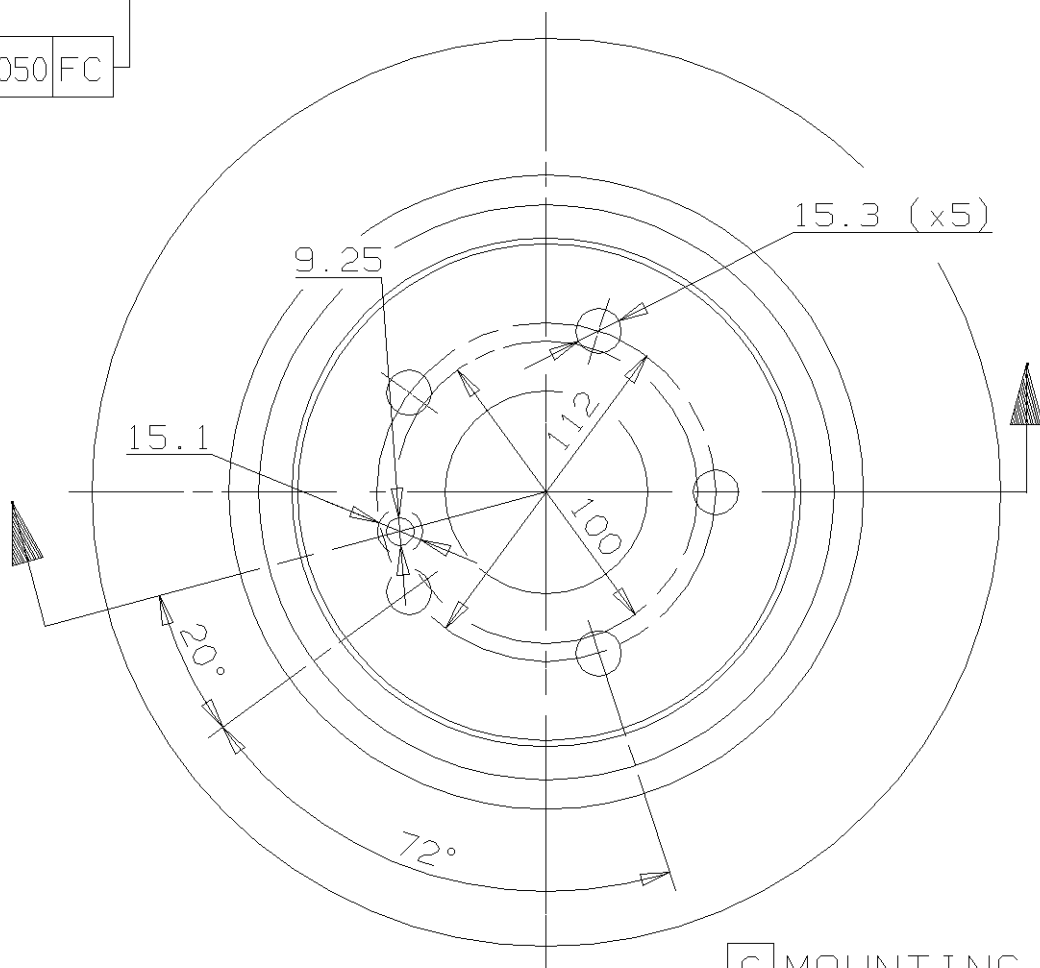

[C] MOUNTING FACE
 Min. TH 8.3 mm
 Weight 5.1 Kg

Type DP