

x 2

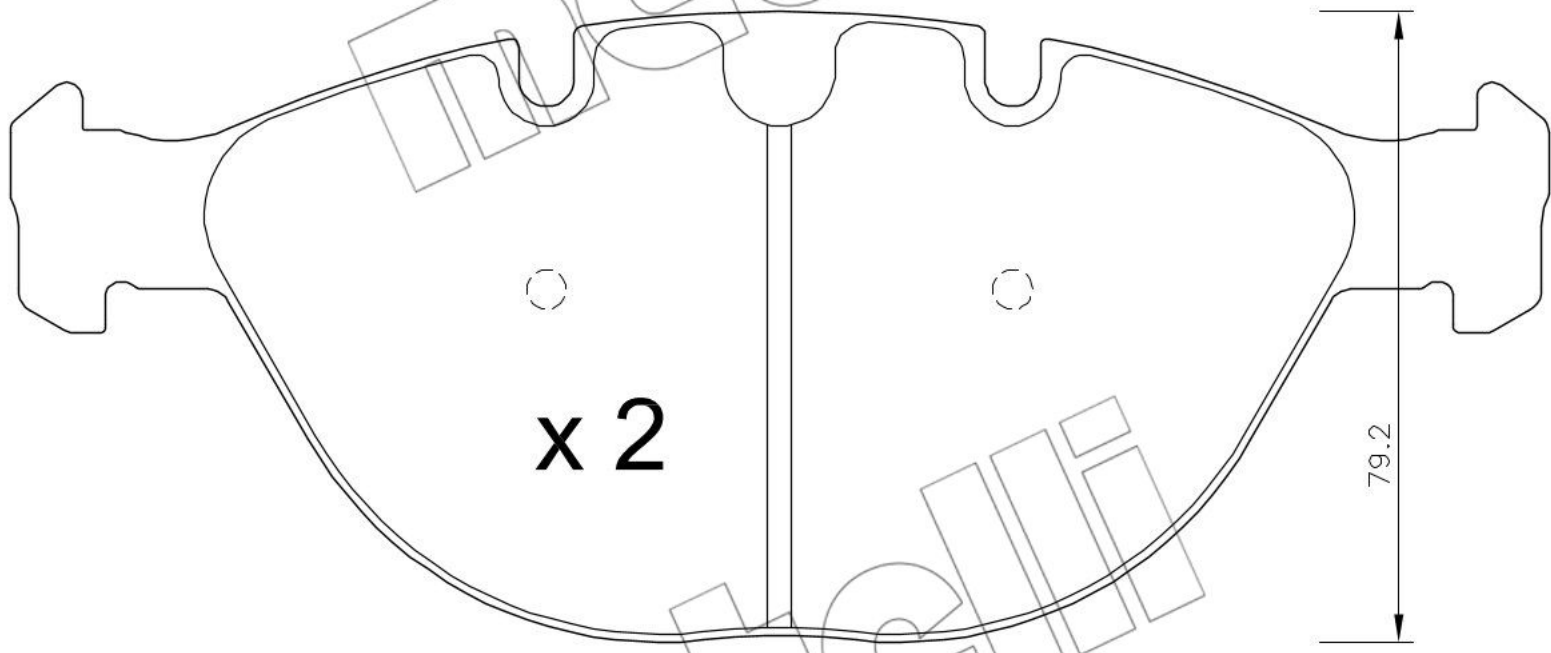
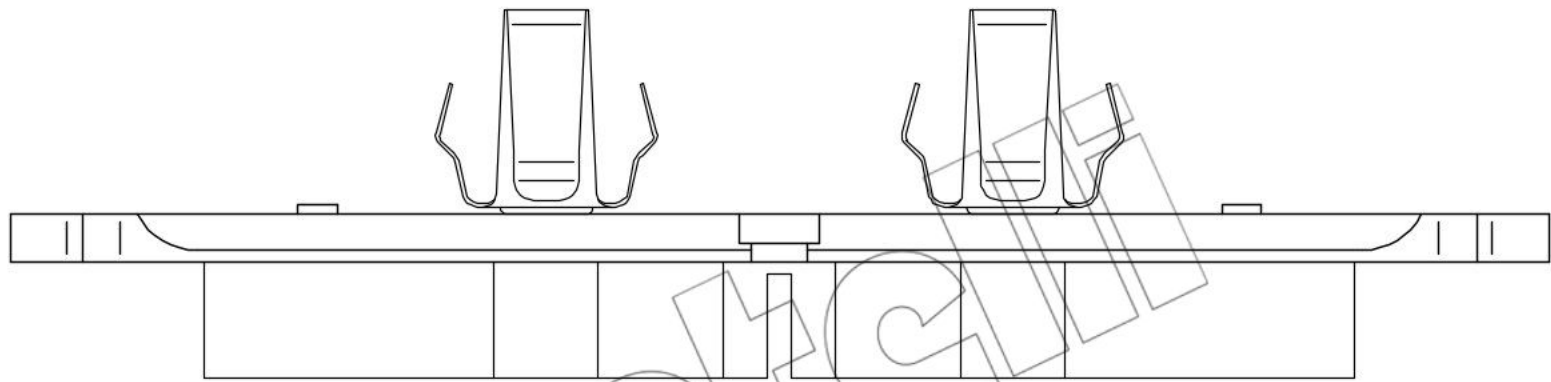

x 2

79.2

193.2

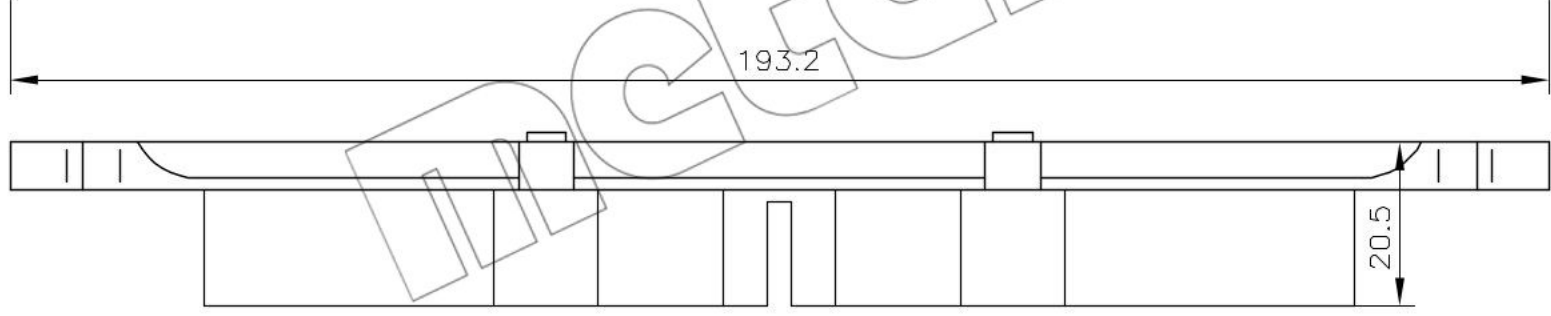

20.5