

L = 155

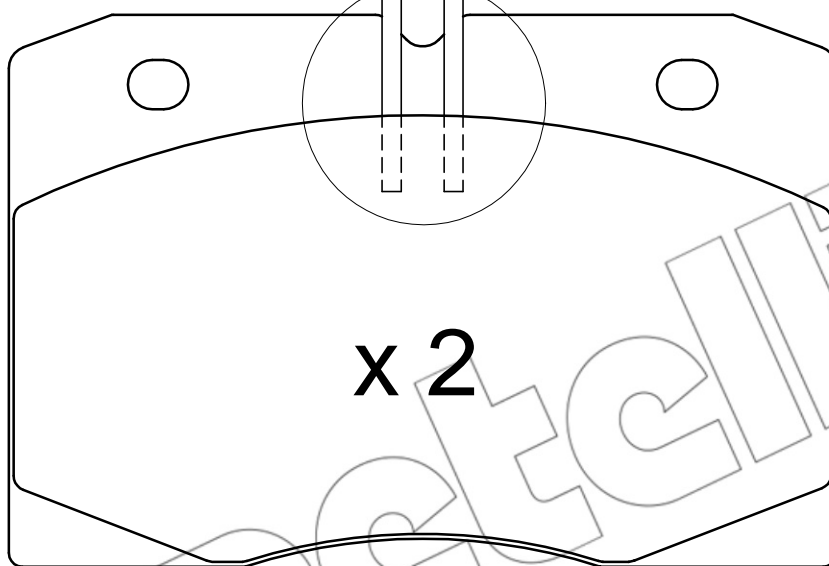

x 2

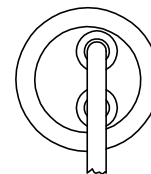
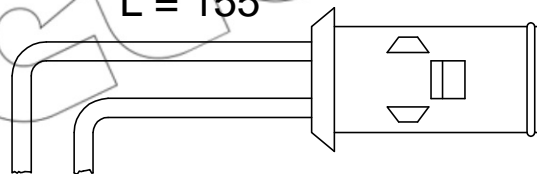
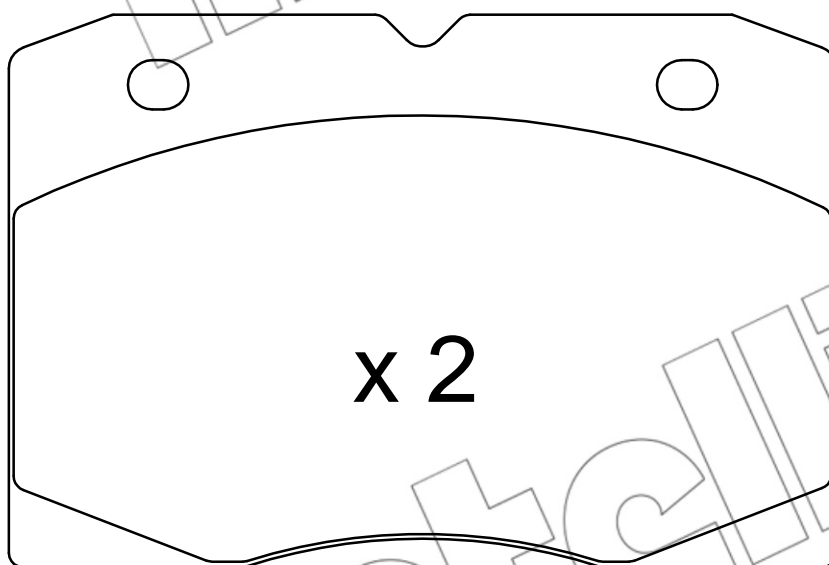
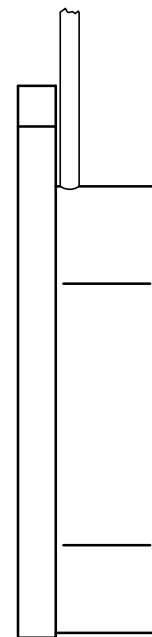

x 2

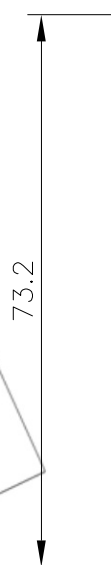

73.2

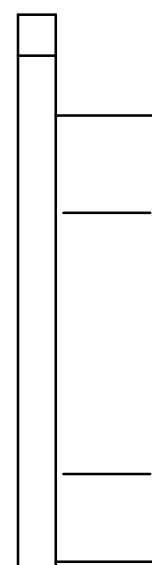

109.5



18.5